

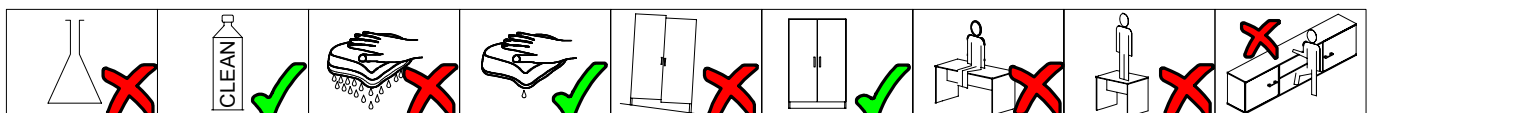



	B 40x	C	D 6x	E	F
	H	J 1x	T	U	V
	W	X 12x	Y 12x	Z1 8x	Z2 2x



2/6 DOLI servis

 1000 N			
E	U	V	W

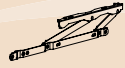
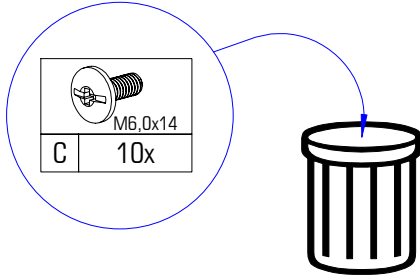
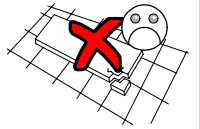
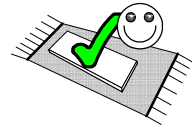



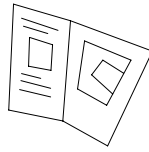

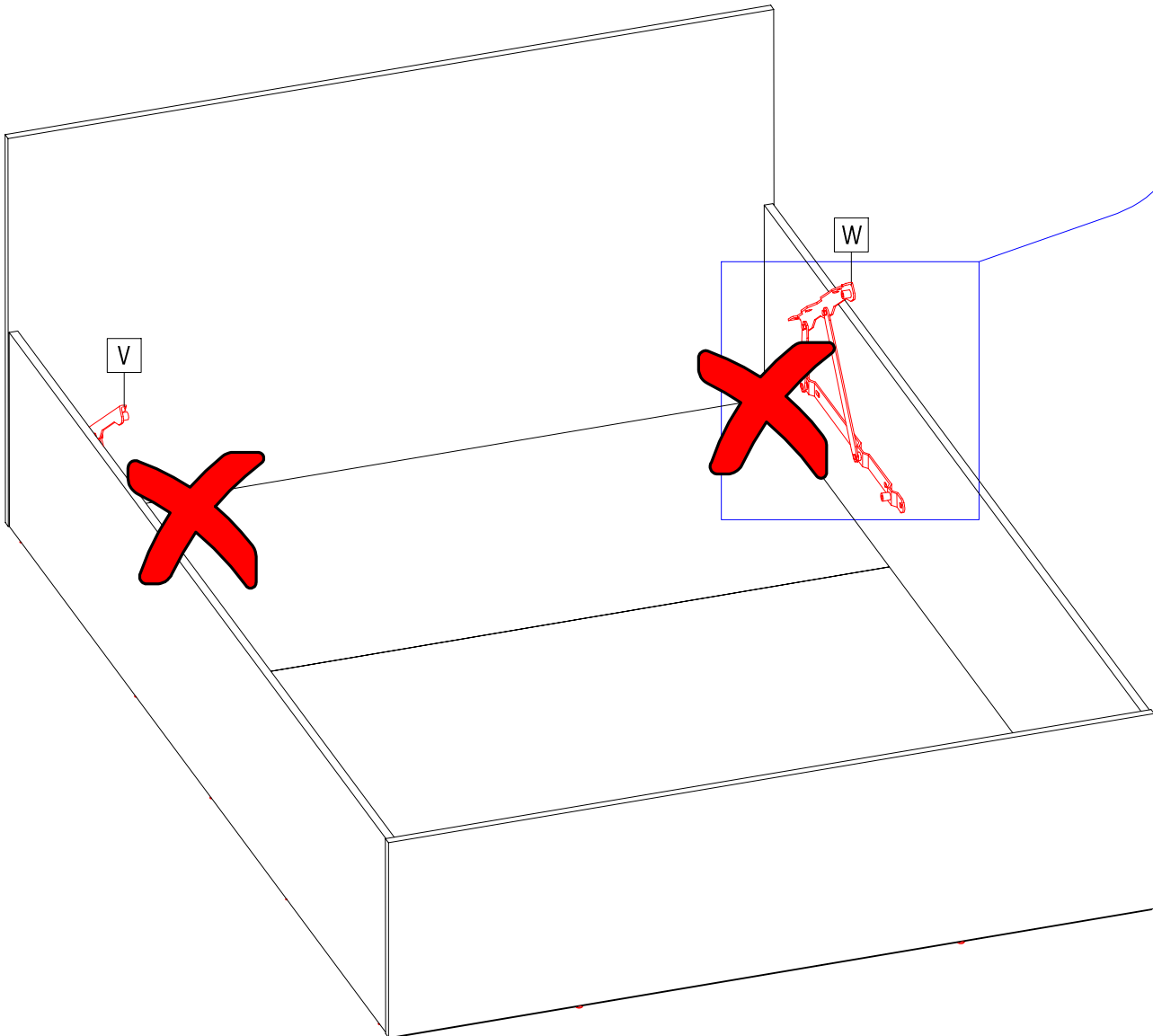
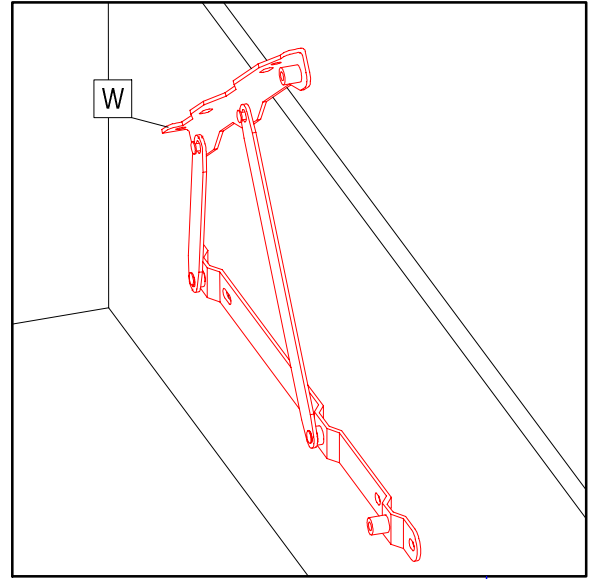

DOLI 140
DOLI 160
DOLI 180



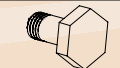
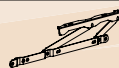



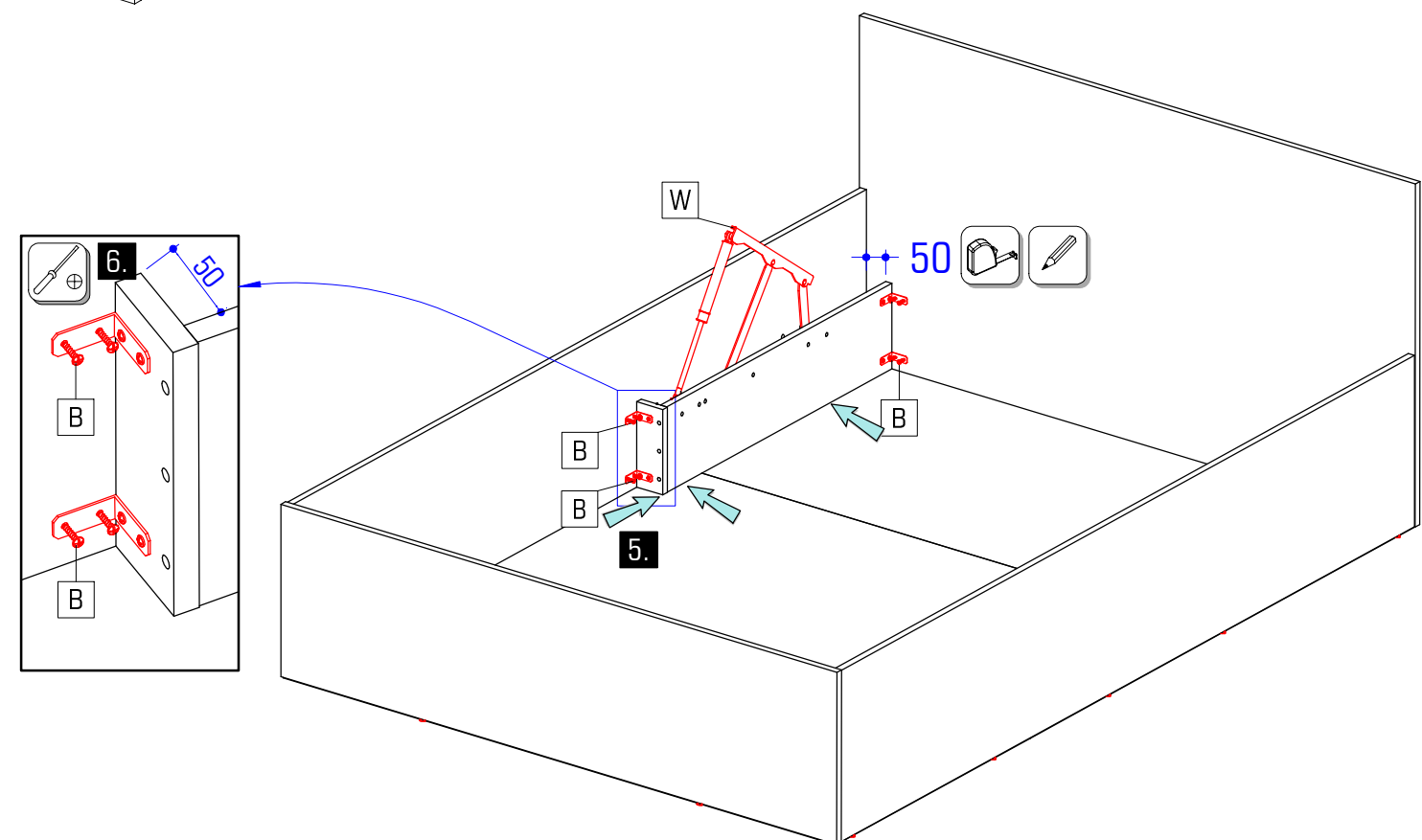
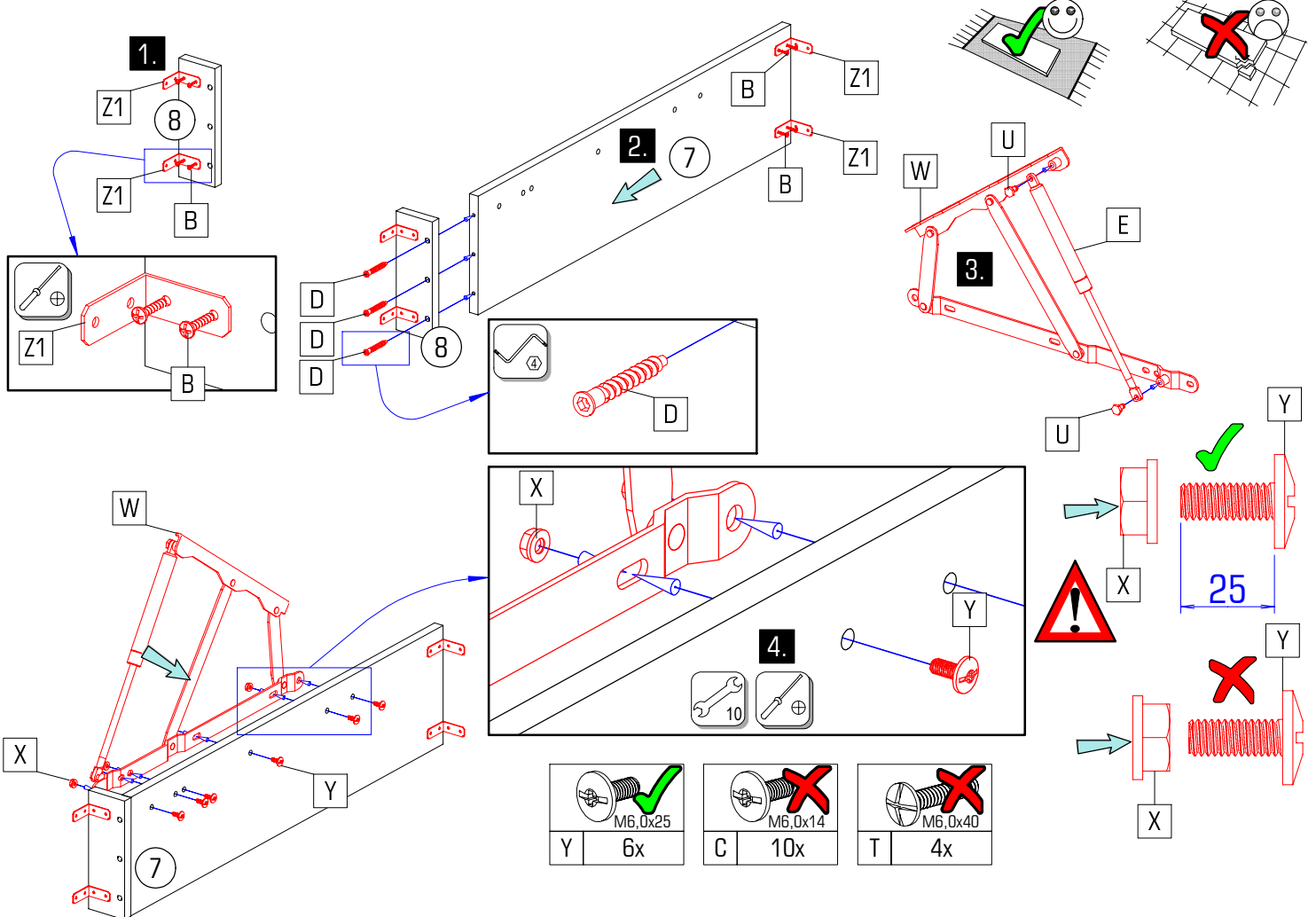

P. 5
P. 6



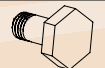

							
B	D	E	U	W	X	Y	Z1
16x	3x	1000 N			6x	6x	4x



4/6 DOLI servis

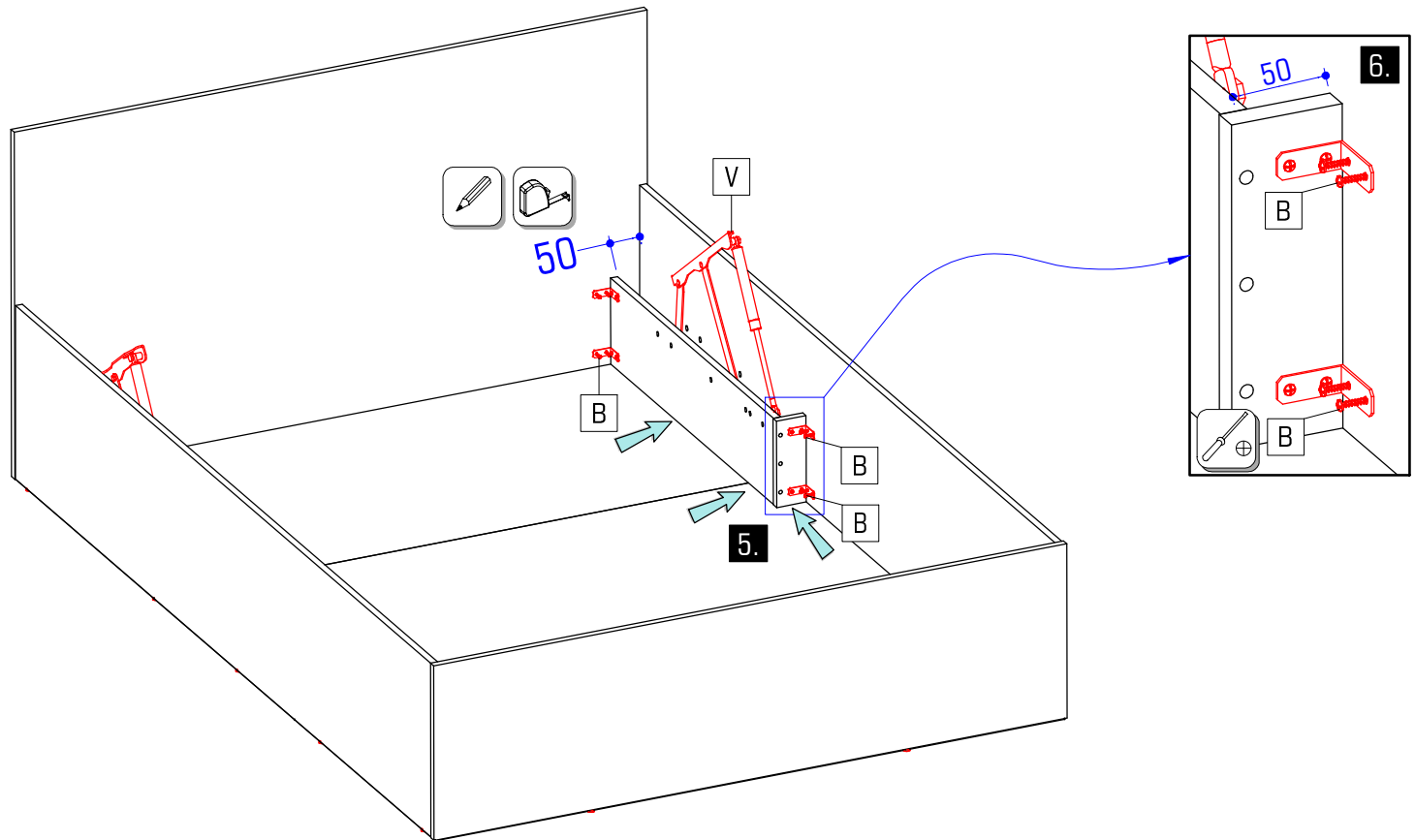
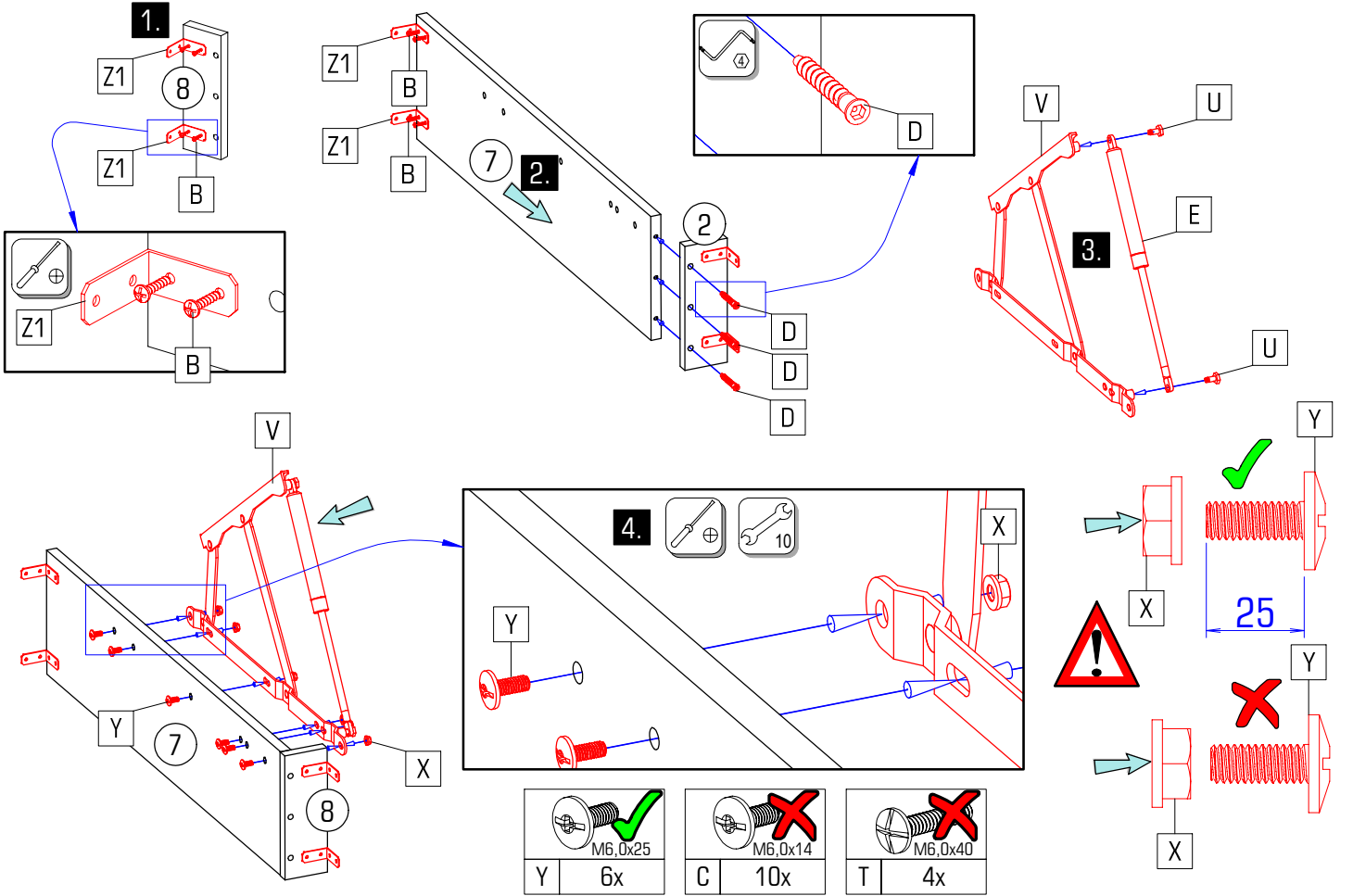



							
B 16x	D 3x	E	U	V	X 6x	Y 6x	Z1 4x

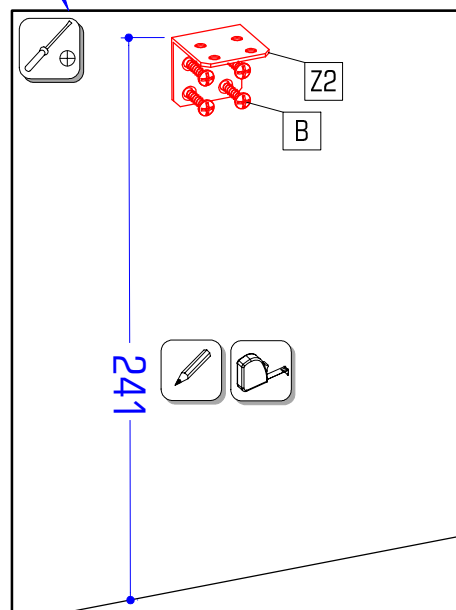
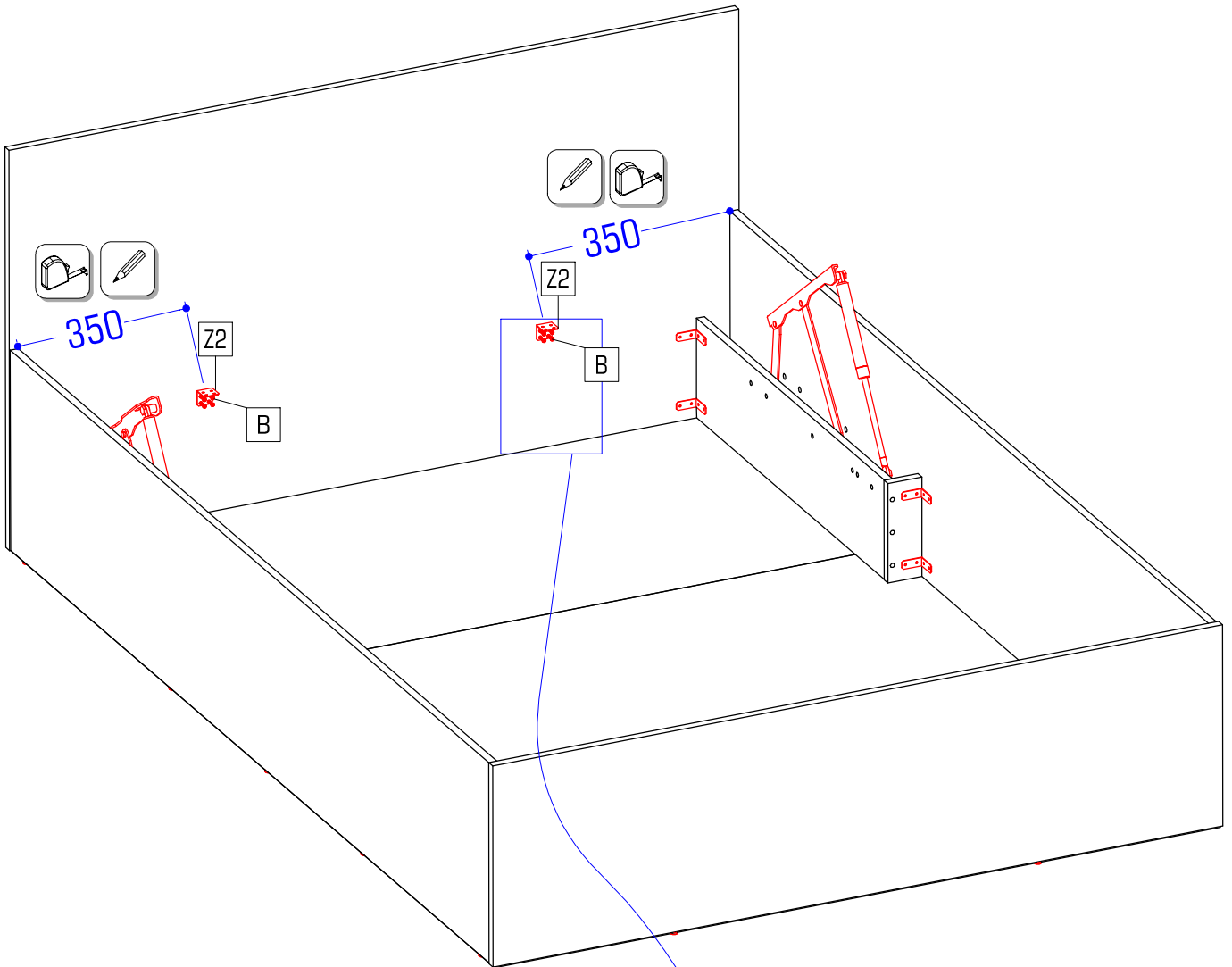

	
Ø5,0x16	30x30x30
B 8x	Z2 2x



6/6 DOLI servis

			M6,0x40		M6,0
F	H	T	4x	X	4x

